

300/00

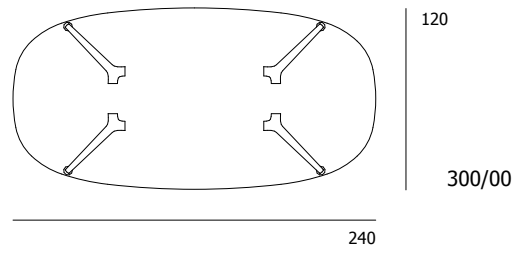

300/00

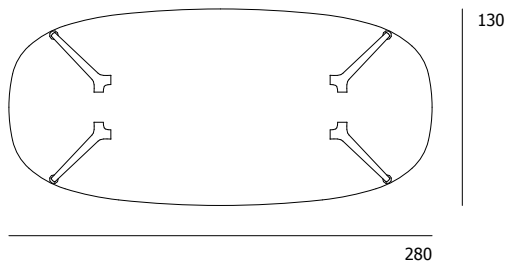
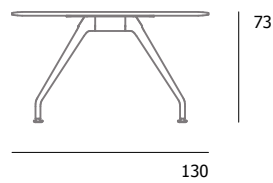
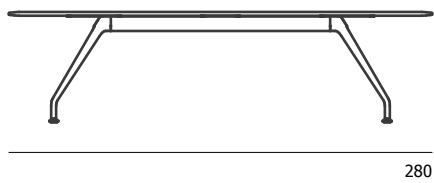

300/00

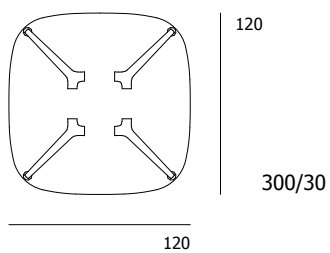
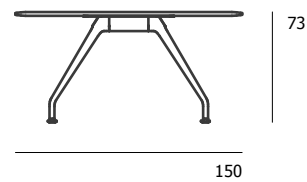
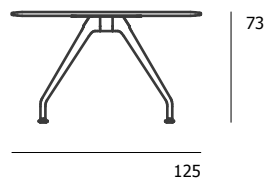
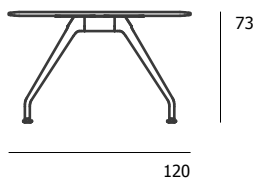

300/30

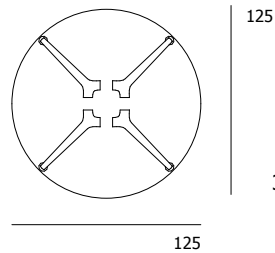

300/30

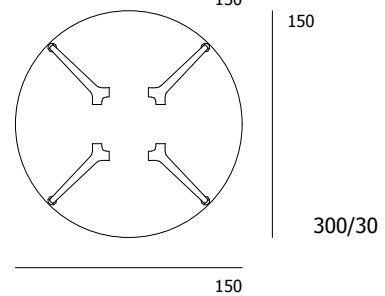

300/30

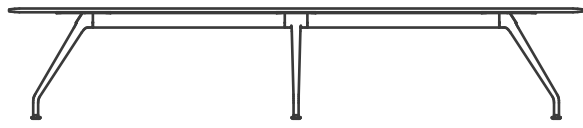

380

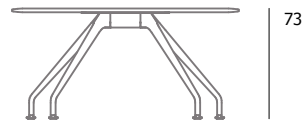

73

150

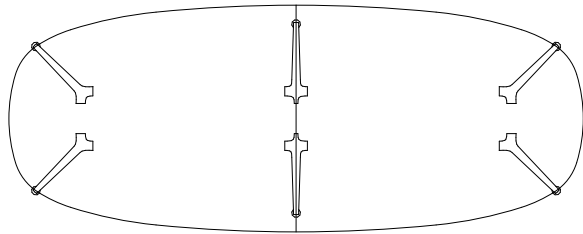

150

300/10

380



540

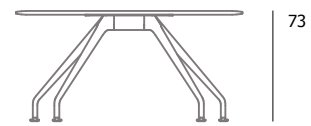

73

150

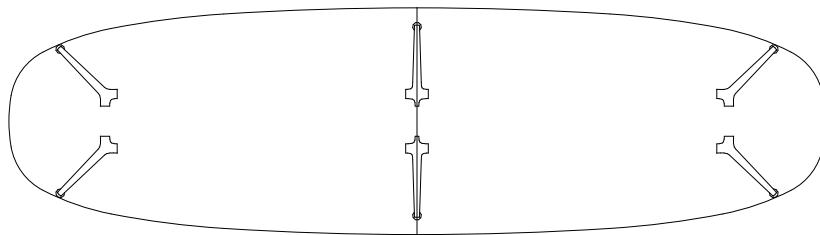

150

300/10

540



540

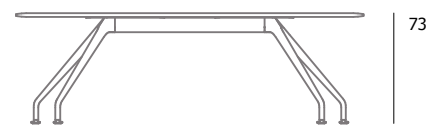

73

230

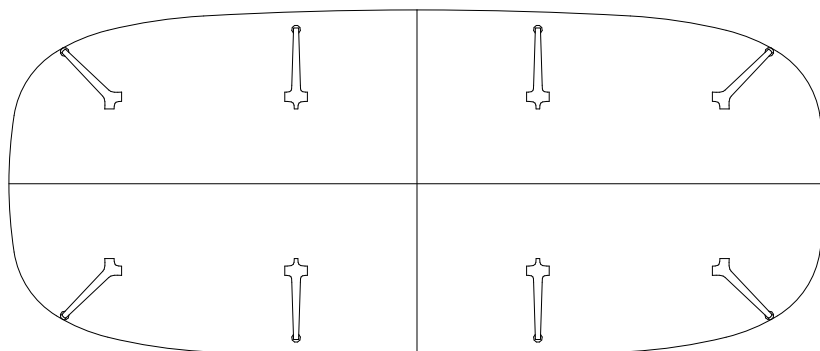

230

300/20

540

